

VAS 294 011A



Granule jet blasting device





Chapter		Page
1.	1. Information regarding this manual	4
	2. Approved operators	4
	3. Explanation of symbols	4
2.	1. Intended use	5
	2. Sources of danger	5
	3. Safety devices	6
	4. Safety precautions at the setup location	7
3.	1. Unpacking the device	8
	2. Identification and description of the device components	8
	3. Device components	9
	4. Technical data	10
4.	1. Operating the granule jet blasting device	10
	2. Preparing and connecting the granule jet blasting device	11
	3. Filling with blast medium	12
	4. Connecting the suction hose to the suction unit	13
	5. Attaching the blast probe to the handle	14
	6. Starting the cleaning process	14
	7. Blasting	15
	8. Cleaning the inlet valves and the inlet channel	16
	9. Shutting down the device	17
5.	1. Maintenance and cleaning	17
	2. Replacement Parts List	19
	3. Warranty	20
	4. Declaration of Conformity	21



www.tkr-support.com

1. Download current owner's manuals
2. Support

This instruction manual is protected by copyright. Any use outside of the boundaries of copyright law without the consent of the manufacturer is not permitted and is punishable by law. This also applies to the extraction of individual illustrations and the use of texts in excerpt form.

1.1 Information regarding this manual

Information Legislation stipulates that users handling hand-guided blasting devices must be trained.

State-of-the-art The granule jet blasting device is state of the art. For the device to function properly, it must be operated in a professional manner in accordance with the safety requirements.

Technical modifications In the interests of quality assurance, we reserve the unrestricted right to implement technical modifications arising from further developments in technology and product improvements without prior notice.

Reading the instruction manual Read the instruction manual carefully before using the device.

Handling All handling necessary to ensure correct operation is described in the owner's manual.

Faults No working method which is not expressly approved by the manufacturer may be used. If the device malfunctions during use, only trained technical personnel are permitted to repair it.

1.2 Approved operators



The machine owner must ensure that the instruction manual is accessible to the operator and that the operator has read and understood it. Only then may the operator use the device.

1.3 Explanation of symbols

In this instruction manual, some sections use internationally known warning symbols, warning notes and general instructional symbols. The individual symbols are explained below.

Follow all instructions and safety rules.



Follow the instruction manual



Wear ear protection



WARNING

When this device is used with nut granulate, allergenic dust is produced.



Observe the general information



Wear gloves



Persons with a nut allergy should not operate the device without adequate protective equipment.



Wear face mask













Wear protective clothing





1.3 Explanation of symbols

	Warning General source of danger		Blow out with air		Arrow to clarify compression
	Warning System under pressure		Clean with air-granules mixture		Arrow indicating direction
	Warning against hearing damage		Audibly engage		For more information, see section ...
	Warning against noise at high sound pressure levels		Please note the following.		

2.1 Intended use

The granule jet blasting device complies with Machine Directive 2006/42 EEC and is used to treat the surface of metal by means of a jet of granules blasted onto the metal surface. Compressed air is used to propel the blast medium.



The granule jet blasting device is used to remove carbonization from the inlet channels and valves of internal combustion engines.



The jet blasting device may only be operated in conjunction with the suction adapters approved for the particular engine type and with a vacuum cleaner with sufficient suction power.



For reasons of safety, no modification or changes to the device are permitted.

2.2 Sources of danger

When used as intended, the granule jet blasting device is safe.



Inappropriate or negligent operation by untrained personnel can lead to serious injuries from the granules emerging from the device.



The blasting probe must never be used without the suction adapter intended for it and a suction device of sufficient power.



Never aim the jet directly at humans or look into the opening of the blasting probe. Risk of injury!

2.2 Sources of danger

Only the hoses which are approved for the intended purpose and its operating pressure are permitted for operating the device.



The device may only be operated by trained personnel.

- Never throw or drop the granule jet blasting device.
- The granule jet blasting device may only be used in ambient temperatures between 5°C and 45°C maximum.
- It is not permitted to use the granule jet blasting device in explosion risk areas!
- The device must never be operated without suitable protective clothing, such as full face protection and protective gloves. There is a risk of injury!



The compressed air must be disconnected and the device depressurized.

Chap. 5.1

The granule jet blasting device may only be operated with compressed air.



The granule jet blasting device must always be set up on a level surface or on the workshop floor. Setting up the device on tables, work benches or other objects is not permitted. (Tank is pressurized!)

Chap. 2.4

Hoses and feed pipes must be laid so that they cannot be damaged or disconnected! The hoses must also be routed in a way that prevents people from tripping over them.

2.3 Safety devices

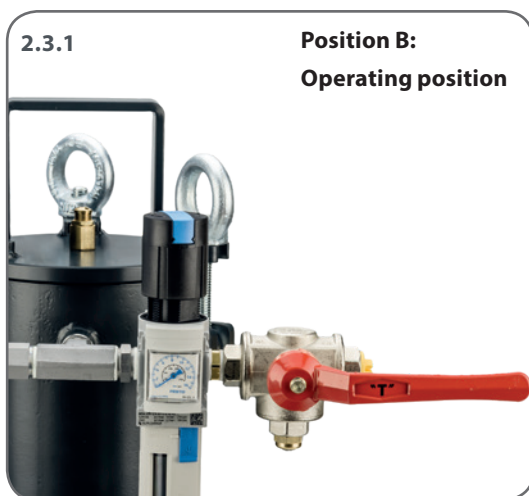

Fig. 2.3.1

On the granules tank, there is a 3-way ball valve which, in the operating position, supplies the tank and the control system with compressed air.

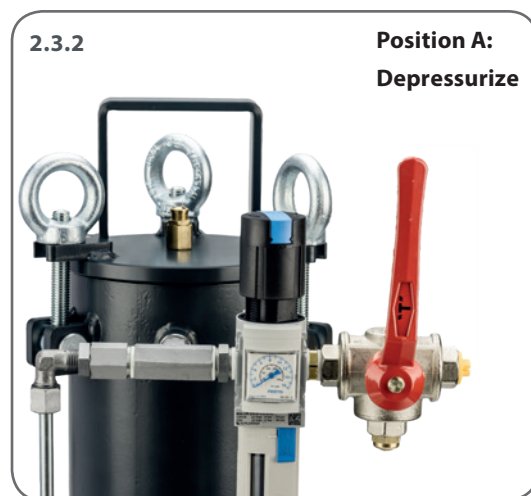

Fig. 2.3.2

In the "Depressurize" position, the tank and the control system are switched to depressurize.



2.3 Safety devices



Fig. 2.3.3

There is a 2-way ball valve on the handle of the blasting probe. This can be operated in the event of failure of a control function. When the ball valve is closed, no air or blasting medium can emerge from the lance.



If a control function fails, the device must be shut down immediately and a repair carried out by trained, technical personnel!



There is a pressure gauge on the granules tank. The operating pressure of the device must never exceed 8 bar. A safety valve is fitted to the granules tank to ensure that the maximum permissible operating pressure of the device is never exceeded. The valve opens when the pressure is approx. 8.5 bar.



If the safety devices malfunction, the device must be shut down immediately! Preventive maintenance must be carried out on the device by a specialist company at least once a year!

2.4 Safety precautions at the setup location

Fig. 2.4.1

The surface where the device is installed must be level and of suitable load carrying capacity for the weight of the device and must be stable.

The device may only be operated in association with the suction adapters designed for the particular engine type and a vacuum cleaner of sufficient size and power.

Hoses and feed pipes must be laid so that they cannot be damaged or disconnected! The hoses must also be routed in a way that prevents people from tripping over them.



3.1 Unpacking the device

3.1.1



- Place the box on a level surface.
- Open the box and carefully remove the device.
- Check the scope of supply:
 - Instruction manual
 - Granules tank with hose assembly attached and handle
 - Straight blasting probe
 - Angled blasting probe
 - 2x seals
 - Suction hose 90°
 - Suction hose 250 mm
 - Nutshell granules in a container

3.2 Identification and description of the device components

Main components of the granule jet blasting device:

Granules blasting medium tank with 3-way ball valve, granules control valve, compressed air control valve and safety valve.

Hose assembly with granules delivery hose and three color-coded control hoses.

Handle with 2-way ball valve and connection for the blasting probe. The control function in the handle is triggered by two series-connected control valves. The operating lever is fitted with a safety device to prevent the equipment restarting unintentionally.

3.3 Device components



3.3.1

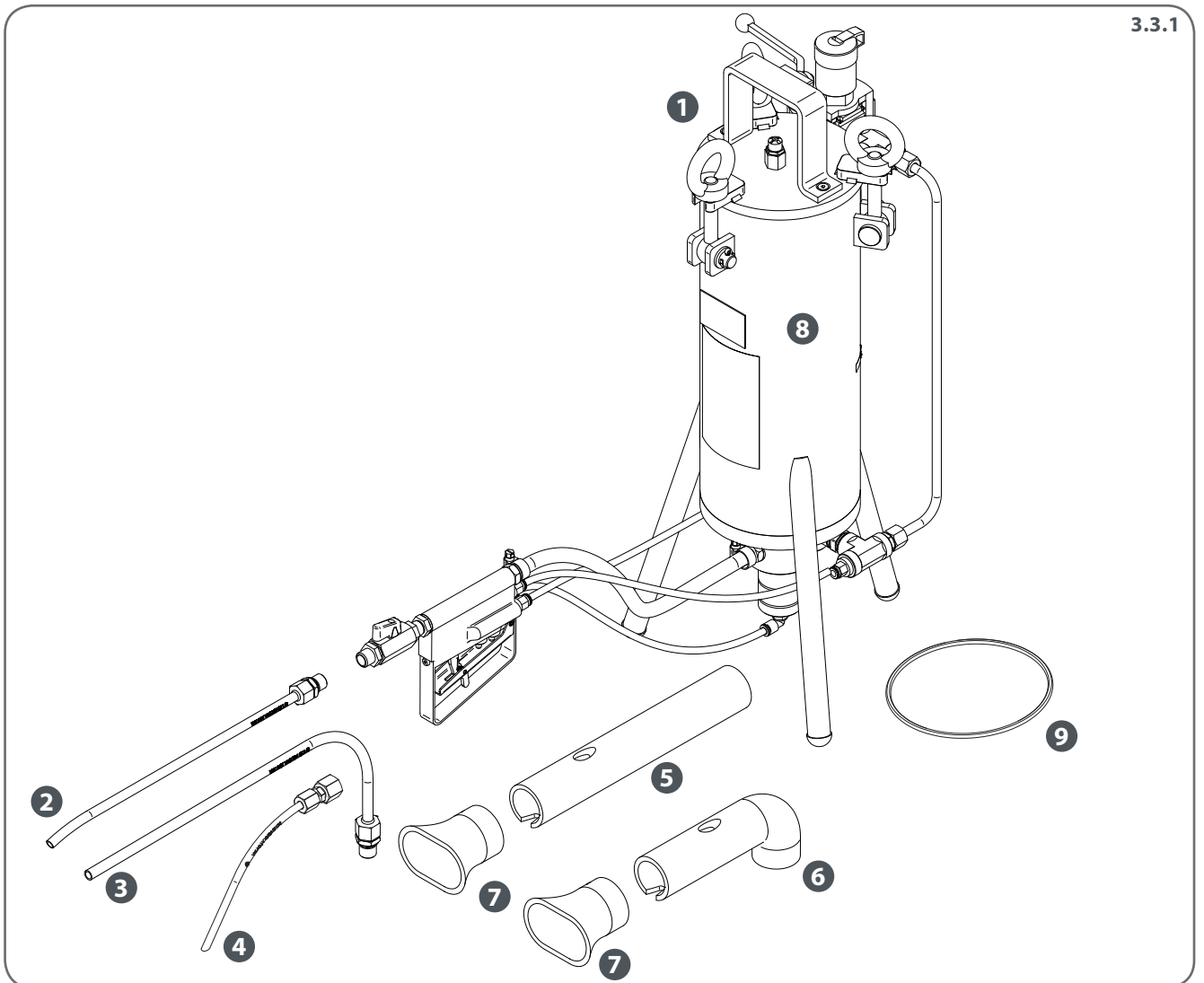

No.	Title	Number
1	Granule blasting device	1
2	Straight blasting probe	1
3	Angled blasting probe	1
4	Blasting probe	1
5	Suction hose 90°	1
6	Suction hose 250 mm	1
7	Seal	2
8	Cleaning granulate	-
9	Operating manual complete	2

3.4 Technical Data

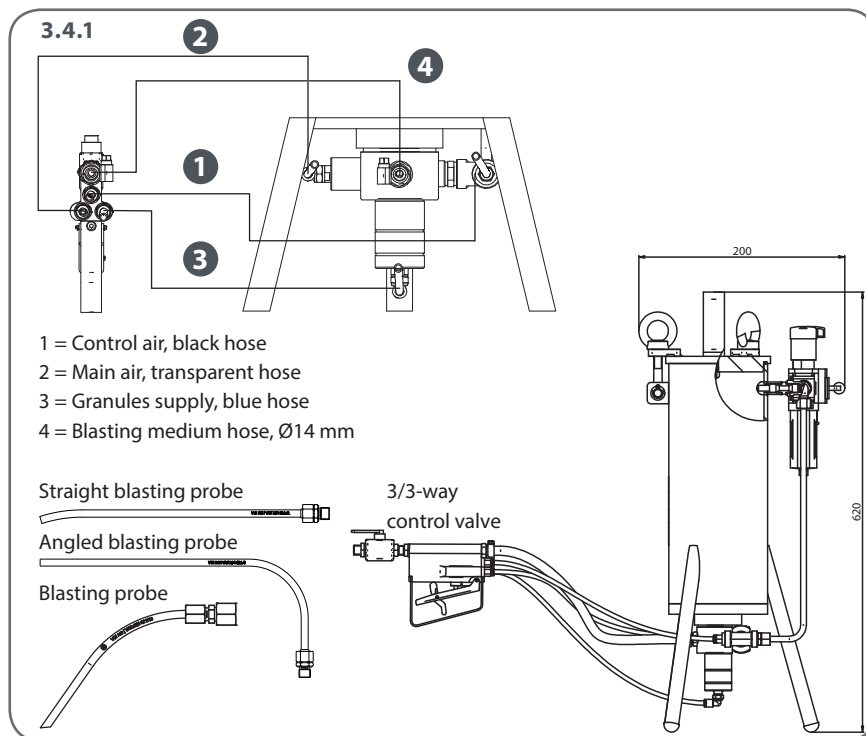

Length	approx. 290 mm
Width	approx. 280 mm
Height	610 mm
max. operating pressure	8 bar
Tank volume	5 l
Weight	16 kg
Hose assembly operating length	4 m

Length and weight without hoses

4.1 Operating the granule jet blasting device

- Fill with blasting granules.
- Connect the suction hose to the suction unit.
- Connect the seal and suction hose together.
- Attach the blast probe to the handle.
- Connect the granule jet blasting device to the compressed air supply.
- Connect the suction hose to the opening of the engine and push the seal on the engine.
- Plug the blasting probe into the opening of the suction hose.
- Start the cleaning process.
- Clean the inlet valves and the inlet channel.
- Blow out: blast with air.
- Stop the compressed air supply.
- Shut down the device.
- Maintain the granule jet blasting device.



**Before starting up the device, always check the condition of the hoses!
 Defective hoses must not be used. Risk of injury!**

4.2 Preparing and connecting the granule jet blasting device



Fig. 4.2.1

The device is supplied from the factory without a compressed air coupling. The ball valve has a 1/4 inch female threaded connection. The thread is provided with a sealing cap.

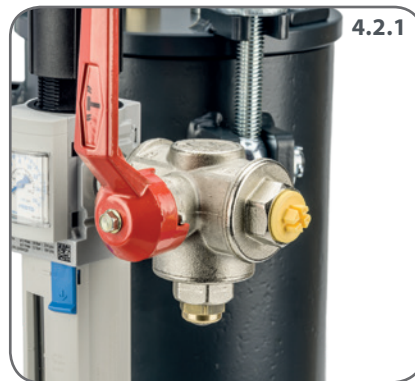

Fig. 4.2.2

Remove the sealing cap.



Fig. 4.2.3

Insert a suitable compressed air connector with seal into the thread.

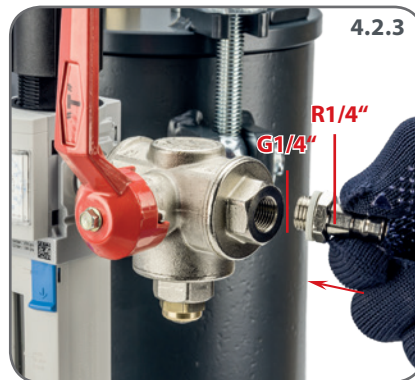
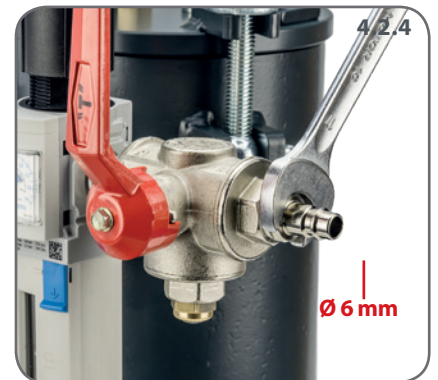

Fig. 4.2.4

Tighten the compressed air connector with a suitable tool.



The device must only be operated with dry, oil-free compressed air!

Fig. 4.2.6

The granule jet blasting device has an integrated supply unit which enables you to adjust the operating pressure.

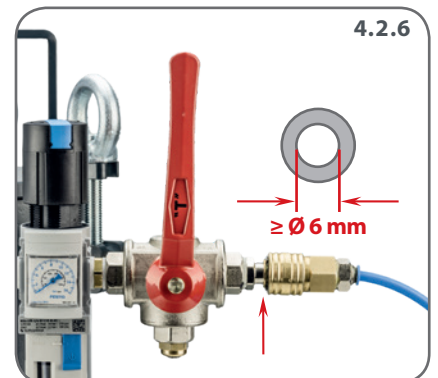
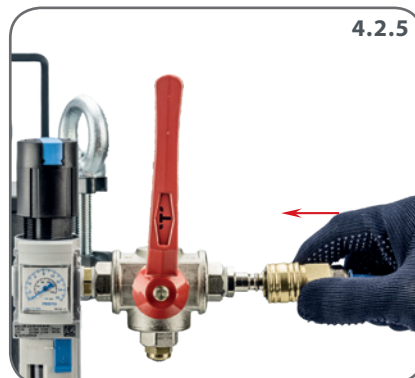
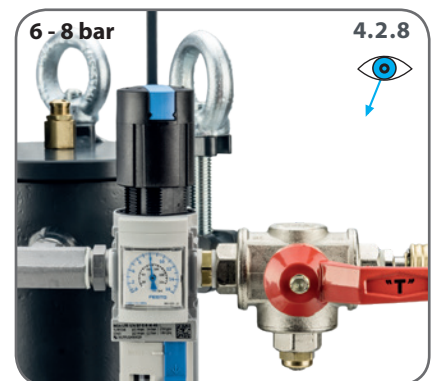

Fig. 4.2.7 / 4.2.8

The operating pressure of the device should be adjusted to between 6 and 8 bar and must never exceed 8 bar!



4.3 Filling with blasting medium



Fig. 4.3.1

3-way ball valve in "Depressurize" position (red lever).



Fig. 4.3.2

Pressure gauge must indicate zero pressure.

Fig. 4.3.3

Undo eyebolts and fold away swivel screw fittings.



Warning! You must only fill the device when the tank is depressurized and disconnected from the supply line.



Fig. 4.3.4

Remove the cover from the tank.



Fig. 4.3.5

Fill with granules.

Fig. 4.3.6

Max. level 20-30 mm below the air supply connection.



Only use a blasting medium which is approved by the manufacturer. The blasting medium must be dry and free of impurities.

Never re-use blasting medium.



4.3 Filling with blasting medium

Fig. 4.3.7

Check the sealing cap. The seal must be clean and must not show any signs of damage.



Fig. 4.3.8

Place the cover on the tank.



Fig. 4.3.9

Engage the swivel screw fittings.



Fig. 4.3.10

Tighten the eyebolts by hand.



Fig. 4.3.11

3-way ball valve in "Depressurize" position.

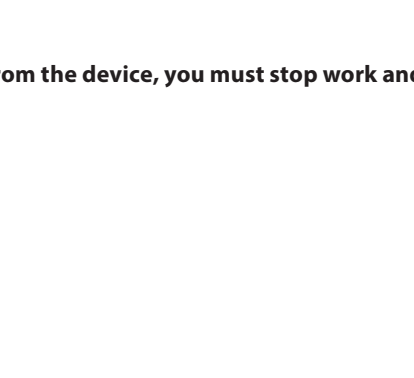

Check the device for leaks!

If compressed air is escaping from the device, you must stop work and eliminate the cause!



4.4 Connecting the suction hose to the suction unit

Fig. 4.4.1

Connect the suction hose to an industrial vacuum cleaner.



Make sure that the suction hose is firmly and securely connected to the vacuum cleaner.



4.4 Connecting the suction hose to the suction unit



Fig. 4.4.2

Fix the suction hose into the inlet channel of the cylinder head.
Then push the seal onto the engine block.



Use the 90° suction hose (red) for transverse engines!
Use the 250 mm suction hose (black) for longitudinal engines!
Close or cover all openings except the one which is being worked on.

4.5 Attaching the blasting probe to the handle

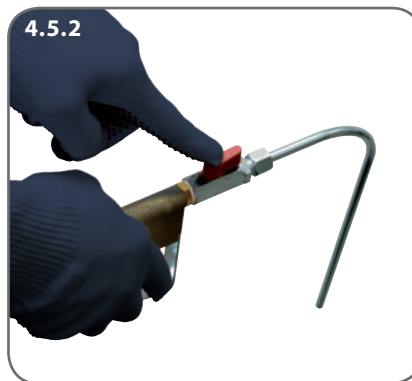
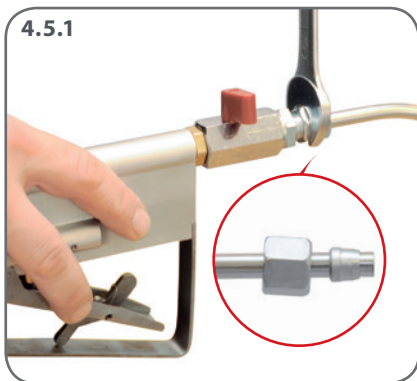

Fig. 4.5.1

Screw on the correct blasting probe to the 2-way ball valve.

Fig. 4.5.2

Turn the 2-way ball valve to the open position.

Fig. 4.5.3

Slowly turn the 3-way ball valve to the operating position.

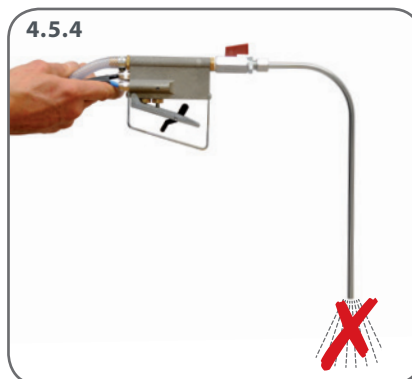

Fig. 4.5.4

No air is to emerge from the blasting probe unless the hand lever is operator.

The device is now ready for use.



4.6 Starting the cleaning process

The operator must put on the prescribed protective clothing before starting the cleaning process!



This device must only be used by trained and instructed technical personnel!

4.7 Blasting

Fig. 4.7.1

Blasting with air / blowing out

When the trigger is moved to Position 1 (half-pressed position), only air flows out of the blasting probe.

This operating position is used for blowing out the area to be cleaned.

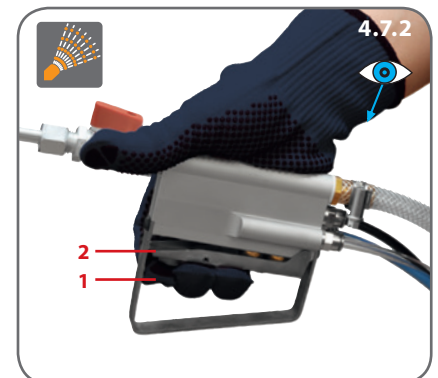
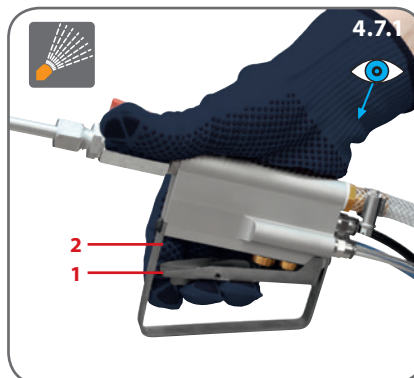

Fig. 4.7.2

Blasting with air granules mixture / cleaning

When the trigger is moved to Position 2 (fully pressed position), air and granules flow out of the blasting probe with considerable power.

This operating position is used for cleaning the coked areas.



**Never pull the blasting probe out of the suction adapter during the cleaning process!
Risk of injury!**

4.8 Cleaning the inlet valves and the inlet channel

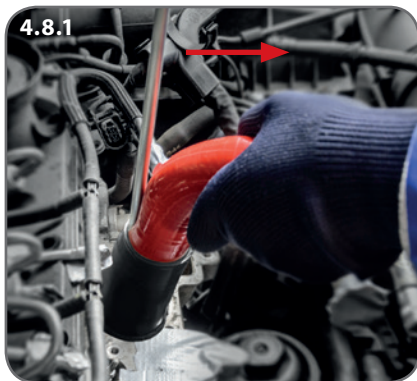

Fig. 4.8.1 – 4.8.4

The blasting probe must be positioned close to the surfaces being cleaned. The cleaning phases should not continue for more than 2-3 seconds. Then the area being cleaned must be flushed and blown out again with air.

Alternate between cleaning and blowing out several times. The blasting probe must be moved to a new position each time in order to clean off all the coked area.



When cleaning and blowing out, blasting medium must not escape from the suction adapter! If blasting medium is escaping, the power of the suction unit is not sufficient.

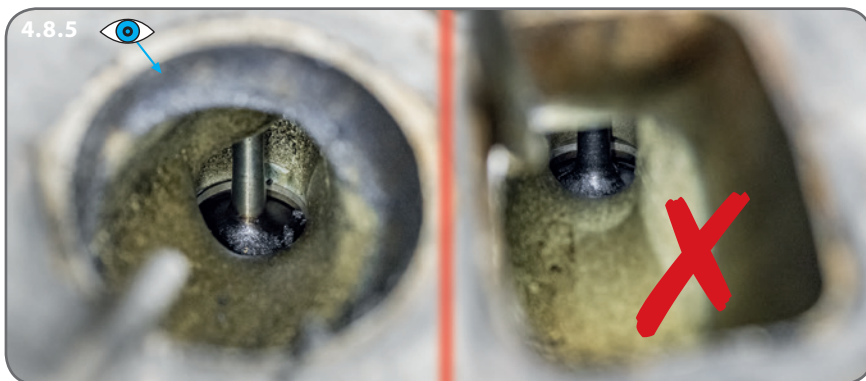

Fig. 4.8.5

When blasting has taken place in all the cleaning positions once, the cleaning result must be inspected visually. If the result is not satisfactory, the procedure must be repeated and/or the operating pressure of the device increased. **Max. 8 bar!**

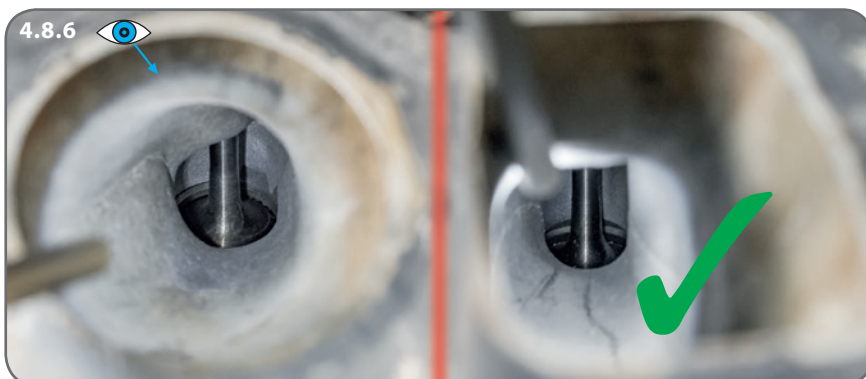

Fig. 4.8.6

The inlet valves and the inlet channel area should be bright and free of coking.



4.9 Shutting down the device

Fig. 4.9.1

After each operation, turn the 3-way ball valve to the “Depressurize” position.

Fig. 4.9.2

The compressed air supply can be disconnected when zero pressure appears on the pressure control valve.

Fig. 4.9.3

Take off the cover of the blasting device and remove any remaining granules.



The granules must always be stored dry!

Never use granules which have already been used!

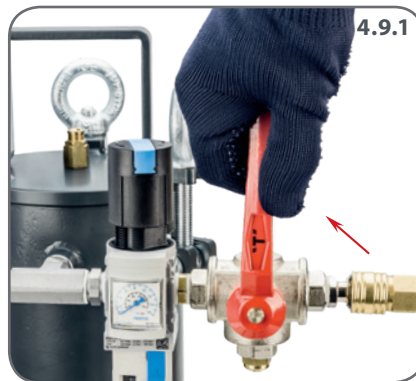

5.1 Maintenance and cleaning

Warning! The blasting medium hose is subject to wear according to use. This must be checked for damage every two months at most.

If the device is used regularly, the blasting medium hose should be replaced once a year!

Fig. 5.1.1

Remove the braided hose from the hose assembly.

Fig. 5.1.2, 5.1.3

Undo the hose clamps from the nozzle on the control valve and on the handle.

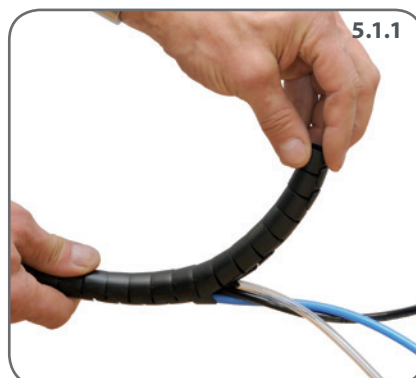

5.1 Maintenance and cleaning

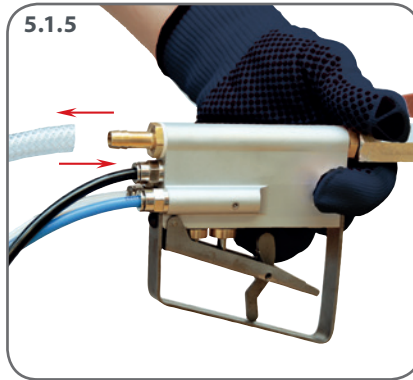
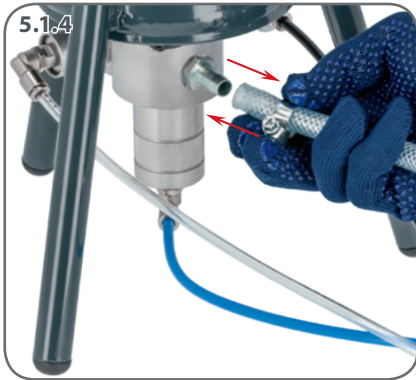
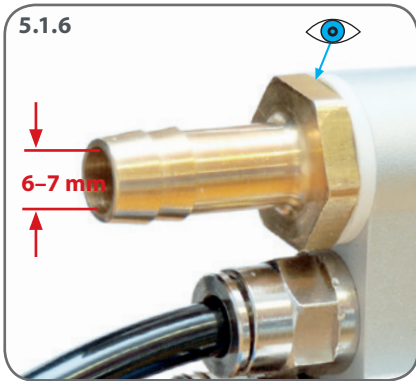

Fig. 5.1.4, 5.1.5

Removing and replacing the hose with a new one.

Fig. 5.1.6

Use this occasion to examine all the hose nozzles and connection nipples on the control valve and on the handle.



If the bore has been significantly enlarged by the flow of blasting medium, this must be renewed!

Original diameter	6 mm
Wear limit diameter	7 mm

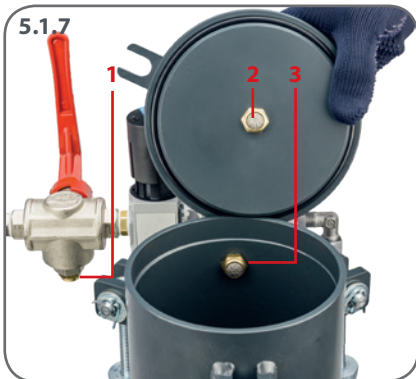
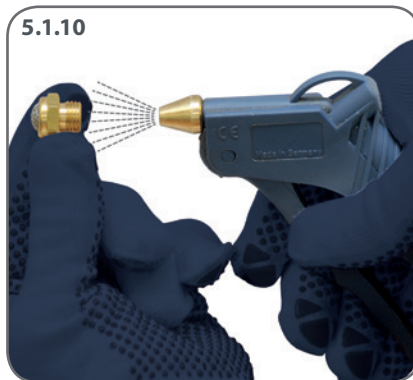
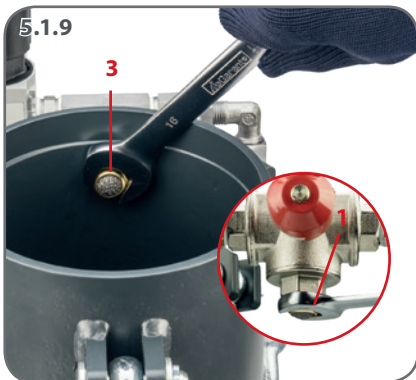

Fig. 5.1.7 – 5.1.9

Clean the filter inserts in the blasting medium tank and the cover of the device at regular intervals - after the tank has been filled 10-15 times at most!

Fig. 5.1.10

Unscrew all the filter inserts and blow them out from the threaded end using a compressed air gun until all traces of granules and dust have gone. After the filter inserts have been cleaned, screw them into the corresponding position again.



Regardless of the normal cleaning and maintenance work, the device must be checked and maintained by a specialist company at least once a year!

5.2 Replacement Parts List



5.2.1



Item No.	Article Number	Title
1	VAS 294 011/1A	Granule blasting device
2	VAS 294 011/2	Straight blasting probe
3	VAS 294 011/3	Angled blasting probe
4	VAS 294 011/4	Suction hose 90°
5	VAS 294 011/5	Suction hose 250 mm
6	VAS 294 011/7	Seal
7	VAS 294 011/8	Cleaning granulate
8	VAS 294 011/9	O-ring
9	VAS 294 011/10	Blasting probe

5.3 Warranty

This device complies with the current safety regulations and was tested before leaving the factory. The device is guaranteed for 24 months against defects due to material or manufacturing defects.

Limitations of warranty

1. The warranty is void if repairs on the device have not been carried out by a specialist company or by the manufacturer.
2. The warranty is void if the device is used for purposes other than those for which it was designed.
3. The warranty is void if the device has not been used in accordance with the instruction manual or if the maintenance work has not been carried out properly.
4. The warranty is void if the device has not been operated properly and/or the approved operating parameters have been exceeded.
5. The warranty is void if the device has been exposed to external effects such as transport damage or damage from impact or collision.
6. Repairs which have not been carried out by an authorized third party center.
7. Normal wear such as blasting probes, blasting hoses including the handle and the granules control valve, is not covered by the warranty.

Service address

TKR Spezialwerkzeuge GmbH
Am Waldesrand 9-11
D-58285 Gevelsberg (Germany)

Phone +49 2332 66607-0
Fax +49 2332 66607-941
E-Mail info@www.tkrgroup.com
Web www.tkrgroup.com

EU Declaration of Conformity

In accordance with the EU Machinery Directive

2006/42/EC

Manufacturer: TKR Spezialwerkzeuge GmbH
Am Waldesrand 9–11
58285 Gevelsberg, Germany

**Person authorized to compile
the technical documents:** Thorsten Weyland

Type of tool: Pneumatically operated granule jet blasting device
Type identification: VAS 294 011A

Has been developed and constructed in accordance
with the standards and guidelines of

TKR Spezialwerkzeuge GmbH
Am Waldesrand 9–11
DE-58285 Gevelsberg (Germany)

Harmonized standards applied: German Product Safety Act (ProdSG)
EN 286-1; EN 614-1; EN ISO 4414;
EN ISO 13849-1
Serial number range: 00001 – 05000

EU Machinery Directive: 2006/42/EC

As manufacturer,

we declare: The products marked accordingly fulfill the requirements
of the directive and standards listed.

Thorsten Weyland

Gevelsberg, 14.02.2019 Thorsten Weyland
Technical Director



Am Waldesrand 9-11
D-58285 Gevelsberg (Germany)

Phone +49 2332 66607-0
Fax +49 2332 66607-941
E-Mail info@tkrgroup.com
Internet www.tkrgroup.com